

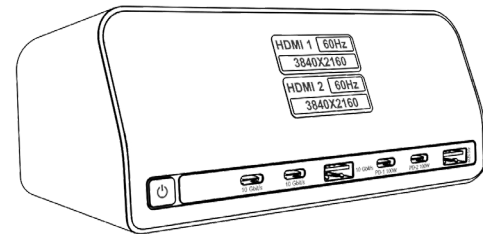

# Heart Dock 2300

11-in-1 DockingStation with 2x HDMI® & LCD-display



1x

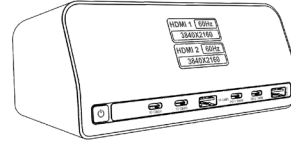

1x



1x

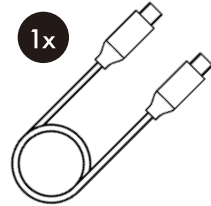

1x

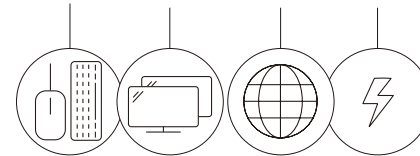
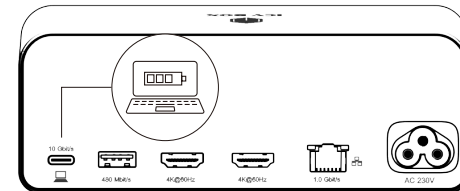
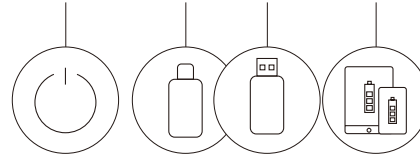
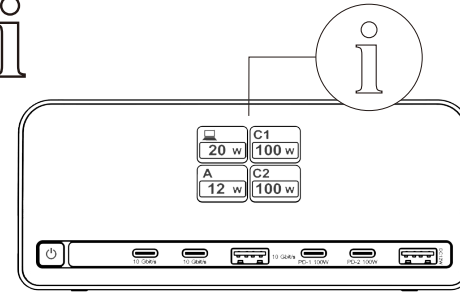
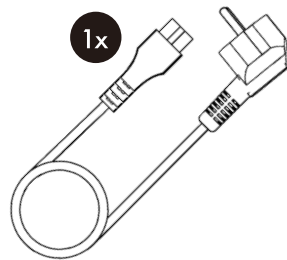

Legacy USB standards	Current USB standards	Data transfer rate
USB 3.0 = USB 3.1 (Gen 1)	= USB 3.2 Gen 1	= 5 Gbit/s
USB 3.1 = USB 3.1 (Gen 2)	= USB 3.2 Gen 2	= 10 Gbit/s
USB 3.2 (Gen 2x2)	= USB 3.2 Gen 2x2	= 20 Gbit/s
	= USB4® Gen 2x1	= 10 Gbit/s
	= USB4® Gen 2x2	= 20 Gbit/s
	= USB4® Gen 3x2	= 40 Gbit/s

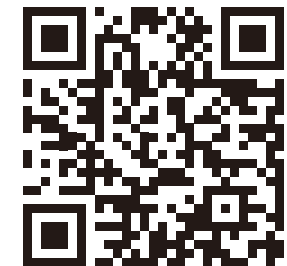

[www.icybox.de](http://www.icybox.de)

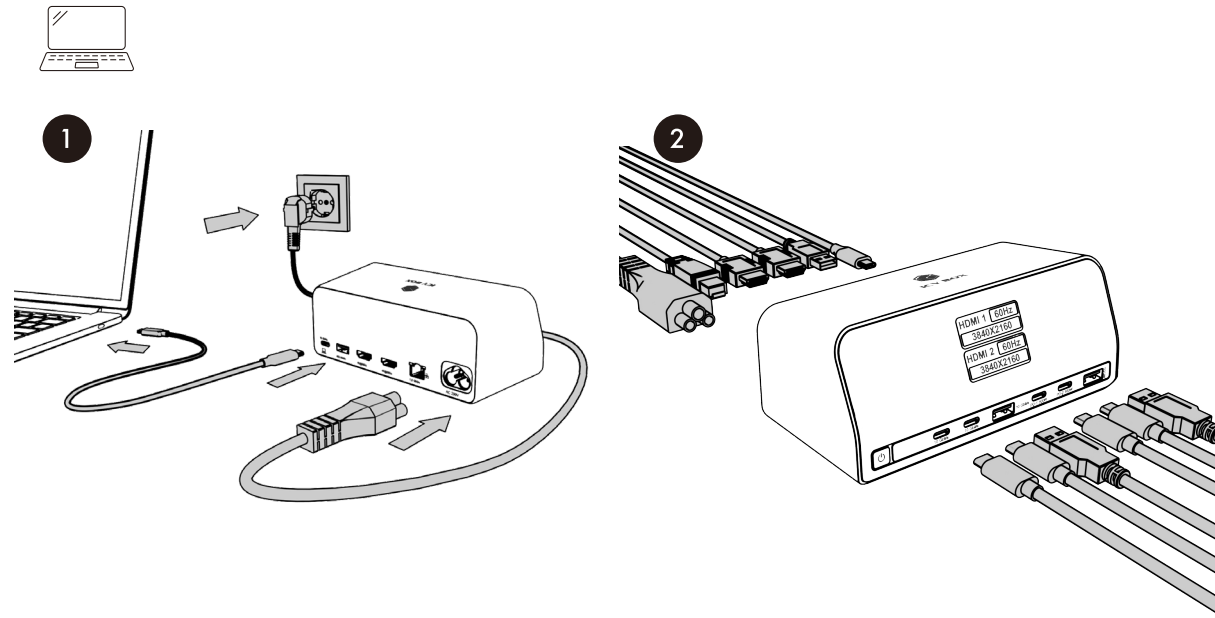

**EN** Startup screen.  
**DE** Startbildschirm.  
**FR** Écran d'accueil.  
**PL** Ekran startowy.

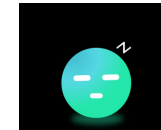

**EN** Standby screen.  
**DE** Standby-Bildschirm.  
**FR** Écran de veille.  
**PL** Ekran czuwania.



**EN** Lights up at full power.  
**DE** Leuchtet bei voller Leistung.  
**FR** S'allume à pleine puissance.  
**PL** Świeci się przy pełnej mocy.



**EN** USB port connected.  
**DE** USB Port verbunden.  
**FR** Port USB connecté.  
**PL** Podłączony port USB.



**EN** USB port not connected.  
**DE** USB Port nicht verbunden.  
**FR** Port USB non connecté.  
**PL** Niepodłączony port USB.



**EN** HDMI® port connected.  
**DE** HDMI® Schnittstelle verbunden.  
**FR** Interface HDMI® connectée.  
**PL** Podłączony port HDMI®.



**EN** HDMI® port not connected.  
**DE** HDMI® Schnittstelle nicht verbunden.  
**FR** Interface HDMI® non connectée.  
**PL** Niepodłączony port HDMI®.



© Copyright 2025 by RaidSonic Technology GmbH. All Rights Reserved.  
 The information contained in this manual is believed to be accurate and reliable. RaidSonic Technology GmbH assumes no responsibility for any errors contained in this manual. RaidSonic Technology GmbH reserves the right to make changes in the specifications and/or design of the above-mentioned product without prior notice. The diagrams contained in this manual may also not fully represent the product that you are using and are there for illustration purposes only. USB Type-C and USB-C are registered trademarks of USB Implementers Forum. The terms HDMI, HDMI High-Definition Multimedia Interface, HDMI Trade dress and the HDMI Logos are trademarks or registered trademarks of HDMI Licensing Administrator, Inc. RaidSonic Technology GmbH assumes no responsibility for any differences between the product mentioned in this manual and the product you may have.